

HANGOVER MONOPOINT SURFACE CANOPY SUSPENSION

| |
|-----------|
| PROJECT |
| TYPE |
| SPECIFIER |
| QUANTITY |
| DATE |

A300153-

| | | | | | | | |
|-------------|-------------------|--------------------|---------------------|-------------------|-------------------|------------|---------------|
| base number | Color Temperature | Finishes (Diamond) | Finishes (Triangle) | Finishes (Circle) | Reflector Options | Shine Ring | Cable Options |
|-------------|-------------------|--------------------|---------------------|-------------------|-------------------|------------|---------------|

- To build a product code in our configurator select the specify button on the base model # product page
- To build a manual product code on this datasheet choose from the options listed below in blue font and add the suffix to the base model #

GENERAL

| |
|--|
| Series: Hangover |
| Subseries: Hangover Monopoint Surface Canopy |
| Partner: Prolicht |
| Division: Architectural |
| Installation: Suspension |
| Product Type: Pendant |
| Mounting Location: Ceiling |
| Light Distribution: Direct |

PHYSICAL

| |
|---|
| Shape: Cylinder |
| Diameter (mm): 40 |
| Diameter (in): 1 9/16 |
| Height (mm): 150 |
| Height (in): 5 7/8 |
| Max. Overall Height (mm): 2150 |
| Max. Overall Height (in): 84 5/8 |
| Weight (kg): 0.75 |
| Weight (lbs): 1.65 |
| Diffuser: Shine Ring 0-6 |
| Fixture Finish: SSR / BKV / CWI / CRY / HAB / UFT / ITA / RUA / FTG / MYG / LOD / PUS / FRO / FUP / KIA / POP / BLS / SPG / MEY / GOH / CHC / COM / ABZ / JAG / OBR / MOS / ROR |
| Fixture Material: Aluminum |
| Cable Details: 2000mm / 6000mm Cable in White / Black / Orange / Red |

ELECTRICAL

| |
|--|
| Lamp Type: LED (Zhaga Standard) |
| Input Wattage (W): 10.9 |
| Total Output Wattage (W): 9 |
| Dimming: Non-Dimmable |
| Driver Included: Yes |
| Driver Location: Integrated |
| Driver Type: Constant Current |
| Driver Class: Class 2 |
| Input Voltage (V): 120 |
| Constant Current (MA): 500 |
| Upon Request: Remote: 0-10Vdc dimming / Phase dimming 120Vac |

LED

| |
|--|
| Number of LEDs: 1 |
| Color Temperature (°K): 2700 / 3000 / 4000 |
| Max. Delivered Lumen (lm): 842 |
| CRI: >90 CRI |
| Lamp Life (hrs): 50000 |

OPTICAL

| |
|--------------------|
| Reflector: 40 / 50 |
|--------------------|

RATINGS AND CERTIFICATIONS

| |
|--|
| Certified By: Certified for North American Standards |
| IP rating: IP20 |

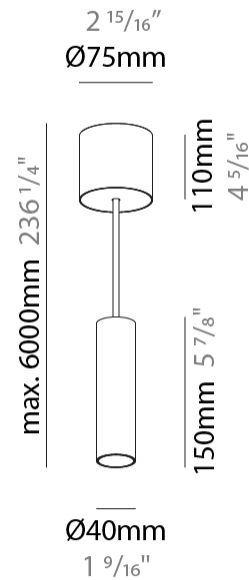
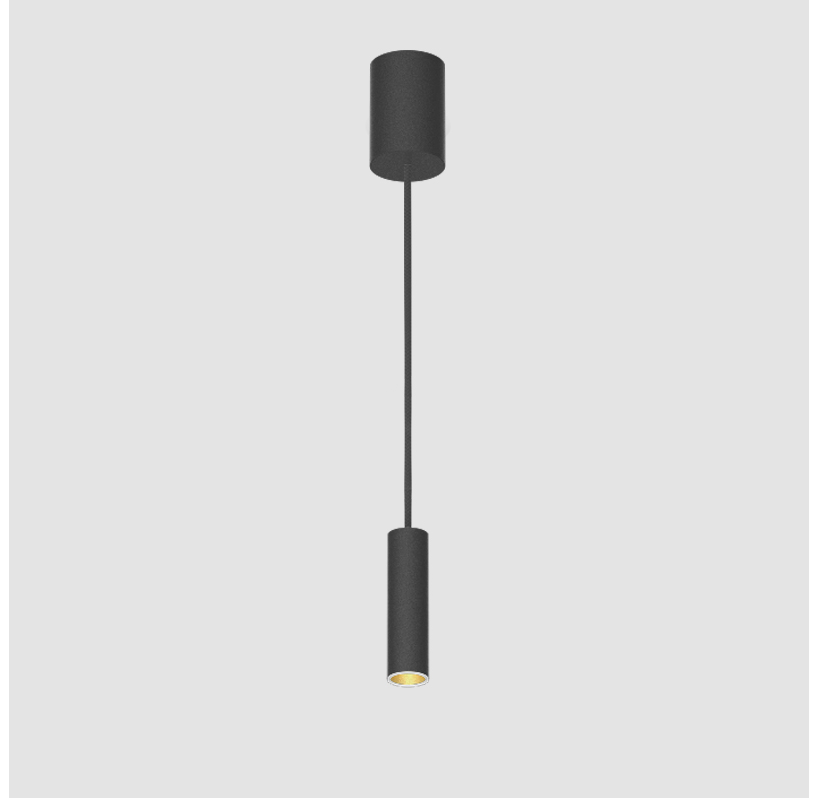

HANGOVER MONOPOINT SURFACE CANOPY SUSPENSION

A300153-

| |
|-----------|
| PROJECT |
| TYPE |
| SPECIFIER |
| QUANTITY |
| DATE |

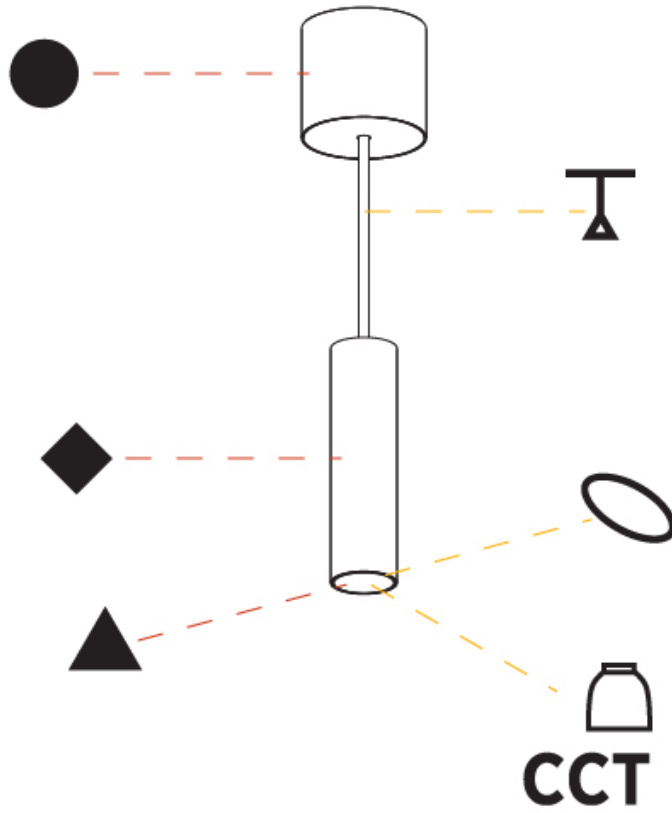

A

HANGOVER MONOPOINT SURFACE CANOPY SUSPENSION

| |
|-----------|
| PROJECT |
| TYPE |
| SPECIFIER |
| QUANTITY |
| DATE |

A300154-

| | | | | | | | |
|-------------|-------------------|--------------------|---------------------|-------------------|-------------------|------------|---------------|
| base number | Color Temperature | Finishes (Diamond) | Finishes (Triangle) | Finishes (Circle) | Reflector Options | Shine Ring | Cable Options |
|-------------|-------------------|--------------------|---------------------|-------------------|-------------------|------------|---------------|

- To build a product code in our configurator select the specify button on the base model # product page
- To build a manual product code on this datasheet choose from the options listed below in blue font and add the suffix to the base model #

GENERAL

Series: Hangover
 Subseries: Hangover Monopoint Surface Canopy
 Partner: Prolicht
 Division: Architectural
 Installation: Suspension
 Product Type: Pendant
 Mounting Location: Ceiling
 Light Distribution: Direct

PHYSICAL

Shape: Cylinder
 Diameter (mm): 40
 Diameter (in): 1 ⁹/₁₆
 Height (mm): 300
 Height (in): 11 ¹³/₁₆
 Max. Overall Height (mm): 2300
 Max. Overall Height (in): 90 ⁹/₁₆
 Diffuser: Shine Ring 0-6
 Fixture Finish: SSR / BKV / CWI / CRY / HAB / UFT / ITA / RUA / FTG / MYG / LOD / PUS / FRO / FUP / KIA / POP / BLS / SPG / MEY / GOH / CHC / COM / ABZ / JAG / OBR / MOS / ROR
 Fixture Material: Aluminum
 Cable Details: 2000mm / 6000mm Cable in White / Black / Orange / Red

ELECTRICAL

Lamp Type: LED (Zhaga Standard)
 Input Wattage (W): 10.9
 Total Output Wattage (W): 9
 Dimming: Non-Dimmable
 Driver Included: Yes
 Driver Location: Integrated
 Driver Type: Constant Current
 Driver Class: Class 2
 Input Voltage (V): 120
 Constant Current (MA): 500
 Upon Request: Remote: 0-10Vdc dimming / Phase dimming 120Vac

LED

Number of LEDs: 1
 Color Temperature (°K): 2700 / 3000 / 4000
 Max. Delivered Lumen (lm): 842
 CRI: >90 CRI
 Efficiency (%): 86
 Lamp Life (hrs): 50000
 Upon Request: ***3500K available in minimum quantities (larger quantities upon request)

OPTICAL

Reflector°: 40 / 50

RATINGS AND CERTIFICATIONS

Certified By: Certified for North American Standards
 IP rating: IP20

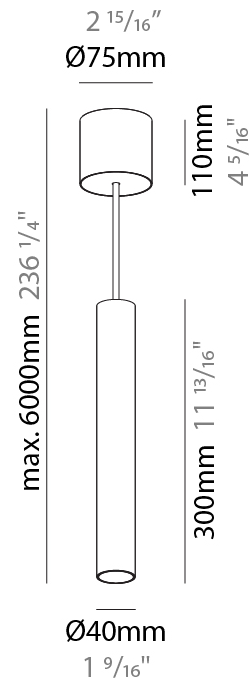

HANGOVER MONOPOINT SURFACE CANOPY SUSPENSION

A300154-

| |
|-----------|
| PROJECT |
| TYPE |
| SPECIFIER |
| QUANTITY |
| DATE |

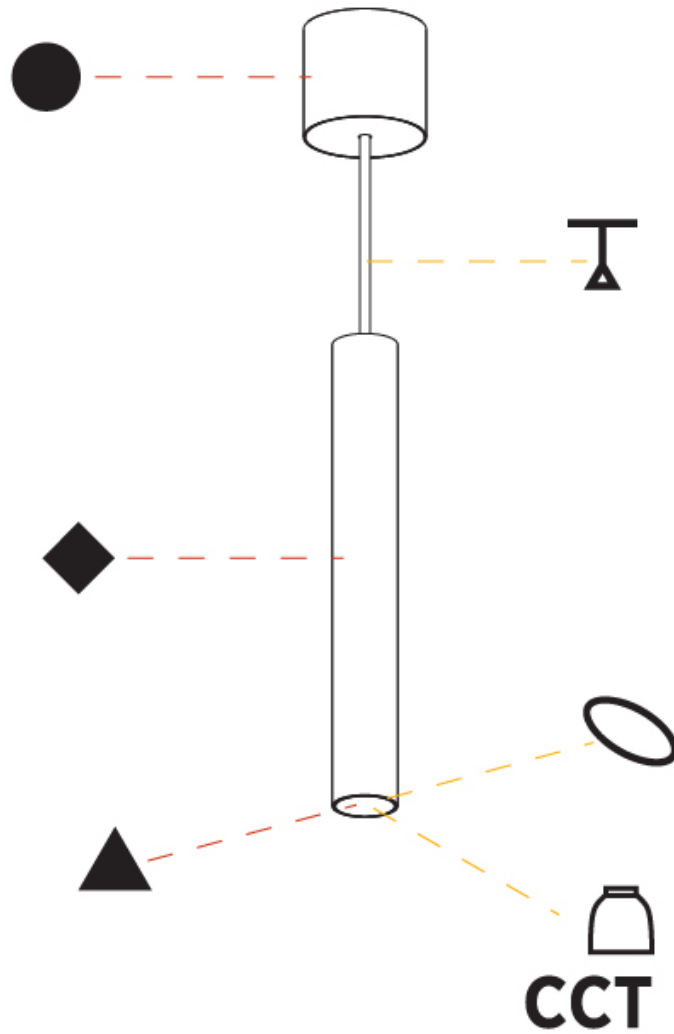

A

| |
|-----------|
| PROJECT |
| TYPE |
| SPECIFIER |
| QUANTITY |
| DATE |

HANGOVER MONOPOINT SURFACE CANOPY SUSPENSION

A300155-

| | | | | | | | |
|-------------|-------------------|--------------------|---------------------|-------------------|-------------------|------------|---------------|
| base number | Color Temperature | Finishes (Diamond) | Finishes (Triangle) | Finishes (Circle) | Reflector Options | Shine Ring | Cable Options |
|-------------|-------------------|--------------------|---------------------|-------------------|-------------------|------------|---------------|

- To build a product code in our configurator select the specify button on the base model # product page
- To build a manual product code on this datasheet choose from the options listed below in blue font and add the suffix to the base model #

GENERAL

| |
|--|
| Series: Hangover |
| Subseries: Hangover Monopoint Surface Canopy |
| Partner: Prolicht |
| Division: Architectural |
| Installation: Suspension |
| Product Type: Pendant |
| Mounting Location: Ceiling |
| Light Distribution: Direct |

PHYSICAL

| |
|---|
| Shape: Cylinder |
| Diameter (mm): 40 |
| Diameter (in): 1 9/16 |
| Height (mm): 450 |
| Height (in): 17 13/16 |
| Max. Overall Height (mm): 2450 |
| Max. Overall Height (in): 96 7/16 |
| Diffuser: Shine Ring 0-6 |
| Fixture Finish: SSR / BKV / CWI / CRY / HAB / UFT / ITA / RUA / FTG / MYG / LOD / PUS / FRO / FUP / KIA / POP / BLS / SPG / MEY / GOH / CHC / COM / ABZ / JAG / OBR / MOS / ROR |
| Fixture Material: Aluminum |
| Cable Details: 2000mm / 6000mm Cable in White / Black / Orange / Red |

ELECTRICAL

| |
|--|
| Lamp Type: LED (Zhaga Standard) |
| Input Wattage (W): 10.9 |
| Total Output Wattage (W): 9 |
| Dimming: Non-Dimmable |
| Driver Included: Yes |
| Driver Location: Integrated |
| Driver Type: Constant Current |
| Driver Class: Class 2 |
| Housing: ENCP3 |
| Input Voltage (V): 120 |
| Constant Current (mA): 500 |
| Upon Request: Remote: 0-10Vdc dimming / Phase dimming 120Vac |

LED

| |
|---|
| Number of LEDs: 1 |
| Color Temperature (°K): 2700 / 3000 / 4000 |
| Max. Delivered Lumen (lm): 842 |
| CRI: >90 CRI |
| Efficiency (%): 86 |
| Lamp Life (hrs): 50000 |
| Upon Request: ***3500K available in minimum quantities (larger quantities upon request) |

OPTICAL

| |
|--------------------|
| Reflector: 40 / 50 |
|--------------------|

RATINGS AND CERTIFICATIONS

| |
|--|
| Certified By: Certified for North American Standards |
| IP rating: IP20 |

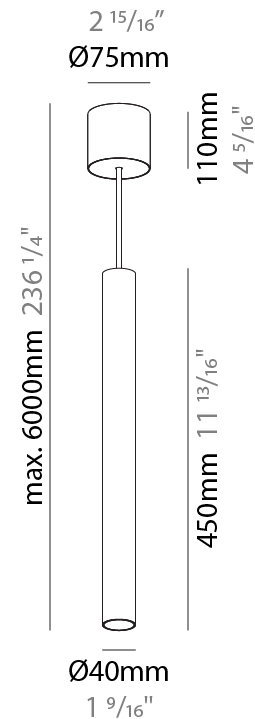
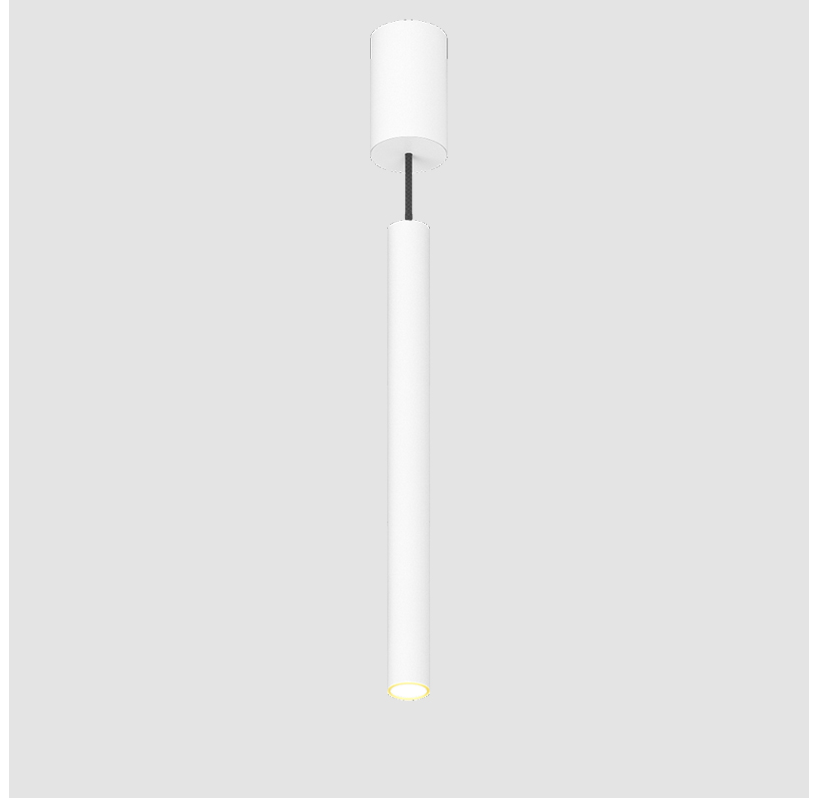

HANGOVER MONOPOINT SURFACE CANOPY SUSPENSION

A300155-

| | |
|-----------|-------|
| PROJECT | _____ |
| TYPE | _____ |
| SPECIFIER | _____ |
| QUANTITY | _____ |
| DATE | _____ |

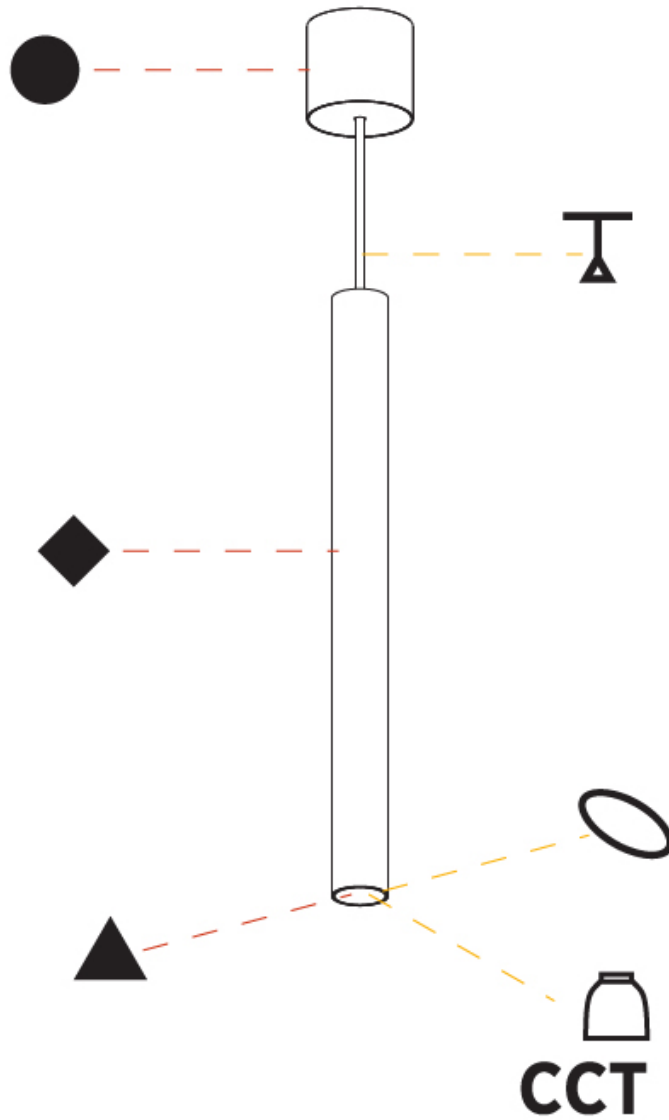

A

| |
|-----------|
| PROJECT |
| TYPE |
| SPECIFIER |
| QUANTITY |
| DATE |

HANGOVER MONOPOINT SURFACE CANOPY SUSPENSION

A300164-

| | | | | | | | |
|-------------|-------------------|--------------------|---------------------|-------------------|-------------------|------------|---------------|
| base number | Color Temperature | Finishes (Diamond) | Finishes (Triangle) | Finishes (Circle) | Reflector Options | Shine Ring | Cable Options |
|-------------|-------------------|--------------------|---------------------|-------------------|-------------------|------------|---------------|

- To build a product code in our configurator select the specify button on the base model # product page
- To build a manual product code on this datasheet choose from the options listed below in blue font and add the suffix to the base model #

GENERAL

| |
|--|
| Series: Hangover |
| Subseries: Hangover Monopoint Surface Canopy |
| Partner: Prolicht |
| Division: Architectural |
| Installation: Suspension |
| Product Type: Pendant |
| Mounting Location: Ceiling |
| Light Distribution: Direct |

PHYSICAL

| |
|---|
| Shape: Cylinder |
| Diameter (mm): 75 |
| Diameter (in): 2 15/16 |
| Height (mm): 150 |
| Height (in): 5 7/8 |
| Max. Overall Height (mm): 2150 |
| Max. Overall Height (in): 84 5/8 |
| Diffuser: Shine Ring 0-6 |
| Fixture Finish: SSR / BKV / CWI / CRY / HAB / UFT / ITA / RUA / FTG / MYG / LOD / PUS / FRO / FUP / KIA / POP / BLS / SPG / MEY / GOH / CHC / COM / ABZ / JAG / OBR / MOS / ROR |
| Fixture Material: Aluminum |
| Cable Details: 2000mm / 6000mm Cable in White / Black / Orange / Red |

ELECTRICAL

| |
|---|
| Lamp Type: LED (Zhaga Standard) |
| Input Wattage (W): 10.95 |
| Total Output Wattage (W): 9.18 |
| Dimming: Non-Dimmable |
| Driver Included: Yes |
| Driver Location: Integrated |
| Driver Type: Constant Current |
| Driver Class: Class 2 |
| Input Voltage (V): 120 |
| Constant Current (MA): 500 |
| Upon Request: Remote: 0-10Vdc dimming / Phase dimming 120Vac / Non-dimming 120/277Vac |

LED

| |
|--|
| Number of LEDs: 1 |
| Color Temperature (°K): 2700 / 3000 / 4000 |
| Max. Delivered Lumen (lm): 923 |
| CRI: >90 CRI |
| Efficiency (%): 86 |
| Lamp Life (hrs): 50000 |

OPTICAL

| |
|--------------------------|
| Reflector°: 18 / 36 / 52 |
|--------------------------|

RATINGS AND CERTIFICATIONS

| |
|--|
| Certified By: Certified for North American Standards |
| IP rating: IP20 |

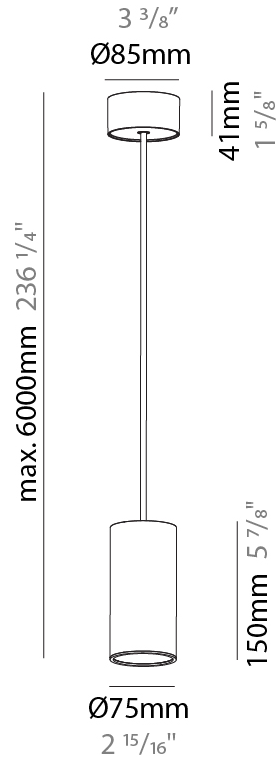

HANGOVER MONOPOINT SURFACE CANOPY SUSPENSION

A300164-

| |
|-----------|
| PROJECT |
| TYPE |
| SPECIFIER |
| QUANTITY |
| DATE |

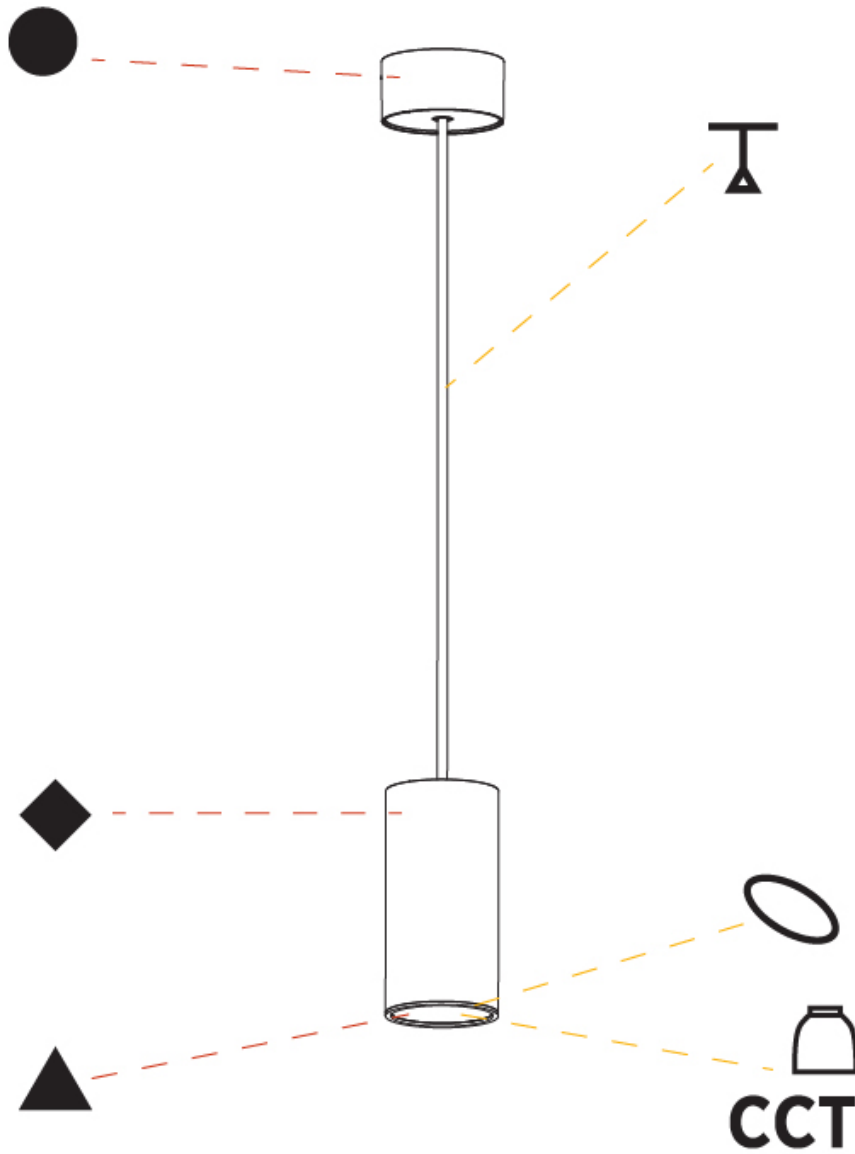

| |
|-----------|
| PROJECT |
| TYPE |
| SPECIFIER |
| QUANTITY |
| DATE |

HANGOVER MONOPOINT SURFACE CANOPY SUSPENSION

A300166-

| | | | | | | | |
|-------------|-------------------|--------------------|---------------------|-------------------|-------------------|------------|---------------|
| base number | Color Temperature | Finishes (Diamond) | Finishes (Triangle) | Finishes (Circle) | Reflector Options | Shine Ring | Cable Options |
|-------------|-------------------|--------------------|---------------------|-------------------|-------------------|------------|---------------|

- To build a product code in our configurator select the specify button on the base model # product page
- To build a manual product code on this datasheet choose from the options listed below in blue font and add the suffix to the base model #

GENERAL

| |
|--|
| Series: Hangover |
| Subseries: Hangover Monopoint Surface Canopy |
| Partner: Prolicht |
| Division: Architectural |
| Installation: Suspension |
| Product Type: Pendant |
| Mounting Location: Ceiling |
| Light Distribution: Direct |

PHYSICAL

| |
|---|
| Shape: Cylinder |
| Diameter (mm): 75 |
| Diameter (in): 2 15/16 |
| Height (mm): 300 |
| Height (in): 11 13/16 |
| Max. Overall Height (mm): 2300 |
| Max. Overall Height (in): 90 9/16 |
| Diffuser: Shine Ring 0-6 |
| Fixture Finish: SSR / BKV / CWI / CRY / HAB / UFT / ITA / RUA / FTG / MYG / LOD / PUS / FRO / FUP / KIA / POP / BLS / SPG / MEY / GOH / CHC / COM / ABZ / JAG / OBR / MOS / ROR |
| Fixture Material: Aluminum |
| Cable Details: 2000mm / 6000mm Cable in White / Black / Orange / Red |

ELECTRICAL

| |
|--|
| Lamp Type: LED (Zhaga Standard) |
| Input Wattage (W): 10.9 |
| Total Output Wattage (W): 9 |
| Dimming: Non-Dimmable |
| Driver Included: Yes |
| Driver Location: Integrated |
| Driver Type: Constant Current |
| Driver Class: Class 2 |
| Housing: ENCP3 |
| Input Voltage (V): 120 |
| Constant Current (MA): 500 |
| Upon Request: Remote: 0-10Vdc dimming / Phase dimming 120Vac |

LED

| |
|--|
| Number of LEDs: 1 |
| Color Temperature (°K): 2700 / 3000 / 4000 |
| Max. Delivered Lumen (lm): 923 |
| CRI: >90 CRI |
| Efficiency (%): 86 |
| Lamp Life (hrs): 50000 |

OPTICAL

| |
|-------------------------|
| Reflector: 18 / 36 / 52 |
|-------------------------|

RATINGS AND CERTIFICATIONS

| |
|--|
| Certified By: Certified for North American Standards |
| IP rating: IP20 |

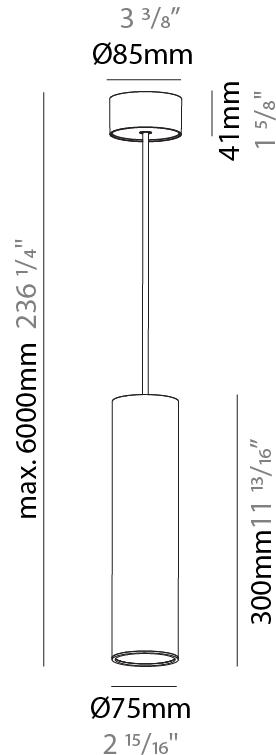

HANGOVER MONOPOINT SURFACE CANOPY SUSPENSION

A300166-

| |
|-----------|
| PROJECT |
| TYPE |
| SPECIFIER |
| QUANTITY |
| DATE |

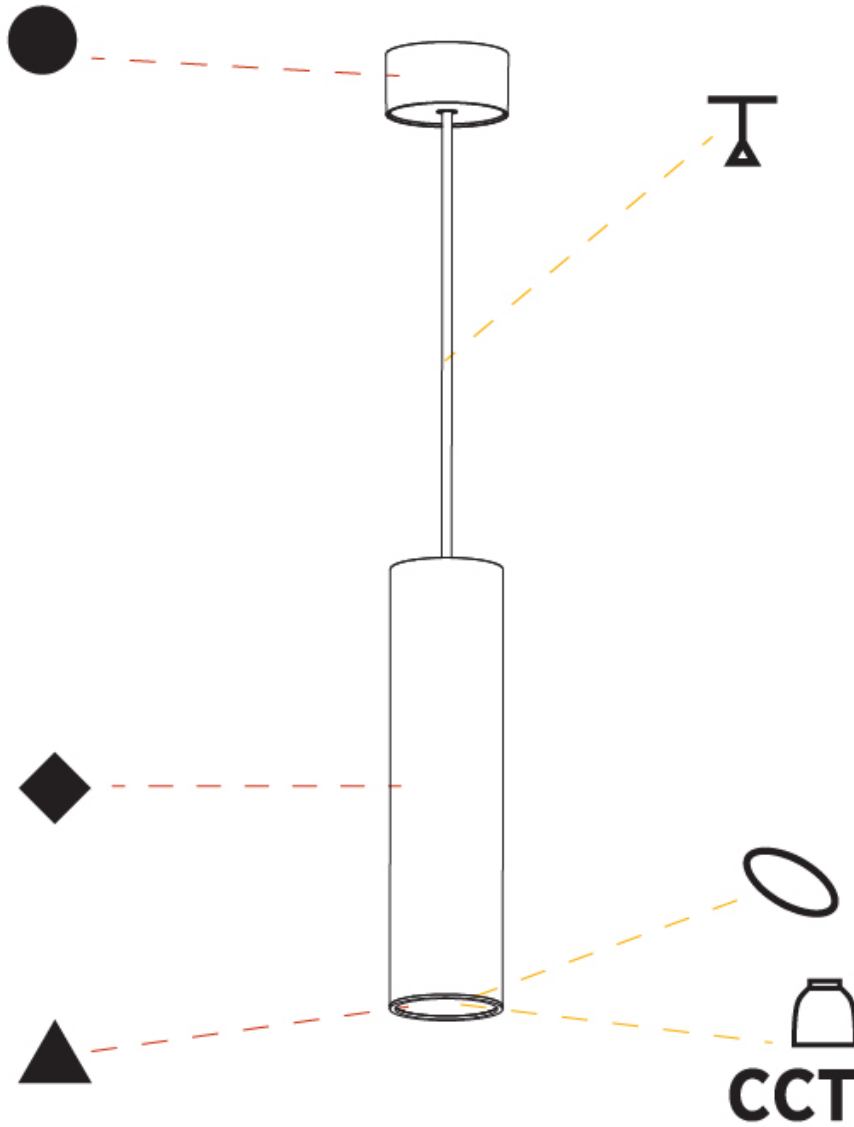

| |
|-----------|
| PROJECT |
| TYPE |
| SPECIFIER |
| QUANTITY |
| DATE |

HANGOVER MONOPOINT SURFACE CANOPY SUSPENSION

A300169-

| | | | | | | | |
|-------------|-------------------|--------------------|---------------------|-------------------|-------------------|------------|---------------|
| base number | Color Temperature | Finishes (Diamond) | Finishes (Triangle) | Finishes (Circle) | Reflector Options | Shine Ring | Cable Options |
|-------------|-------------------|--------------------|---------------------|-------------------|-------------------|------------|---------------|

- To build a product code in our configurator select the specify button on the base model # product page
- To build a manual product code on this datasheet choose from the options listed below in blue font and add the suffix to the base model #

GENERAL

| |
|--|
| Series: Hangover |
| Subseries: Hangover Monopoint Surface Canopy |
| Partner: Prolicht |
| Division: Architectural |
| Installation: Suspension |
| Product Type: Pendant |
| Mounting Location: Ceiling |
| Light Distribution: Direct |

PHYSICAL

| |
|---|
| Shape: Cylinder |
| Diameter (mm): 75 |
| Diameter (in): 2 ¹⁵ / ₁₆ |
| Height (mm): 450 |
| Height (in): 17 ¹¹ / ₁₆ |
| Max. Overall Height (mm): 2450 |
| Max. Overall Height (in): 96 ⁷ / ₁₆ |
| Diffuser: Shine Ring 0-6 |
| Fixture Finish: SSR / BKV / CWI / CRY / HAB / UFT / ITA / RUA / FTG / MYG / LOD / PUS / FRO / FUP / KIA / POP / BLS / SPG / MEY / GOH / CHC / COM / ABZ / JAG / OBR / MOS / ROR |
| Fixture Material: Aluminum |
| Cable Details: 2000mm / 6000mm Cable in White / Black / Orange / Red |

ELECTRICAL

| |
|--|
| Lamp Type: LED (Zhaga Standard) |
| Input Wattage (W): 20 |
| Total Output Wattage (W): 18.9 |
| Dimming: Non-Dimmable |
| Driver Included: Yes |
| Driver Location: Integrated |
| Driver Type: Constant Current |
| Driver Class: Class 2 |
| Housing: ENCP3 |
| Input Voltage (V): 120 |
| Constant Current (MA): 500 |
| Upon Request: Remote: 0-10Vdc dimming / Phase dimming 120Vac |

LED

| |
|--|
| Number of LEDs: 1 |
| Color Temperature (°K): 2700 / 3000 / 4000 |
| Max. Delivered Lumen (lm): 1680 |
| CRI: >90 CRI |
| Efficiency (%): 86 |
| Lamp Life (hrs): 50000 |

OPTICAL

| |
|-------------------------|
| Reflector: 18 / 36 / 52 |
|-------------------------|

RATINGS AND CERTIFICATIONS

| |
|--|
| Certified By: Certified for North American Standards |
| IP rating: IP20 |

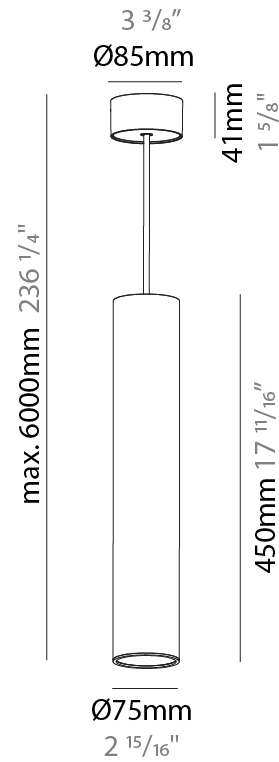

HANGOVER MONOPOINT SURFACE CANOPY SUSPENSION

A300169-

| |
|-----------|
| PROJECT |
| TYPE |
| SPECIFIER |
| QUANTITY |
| DATE |

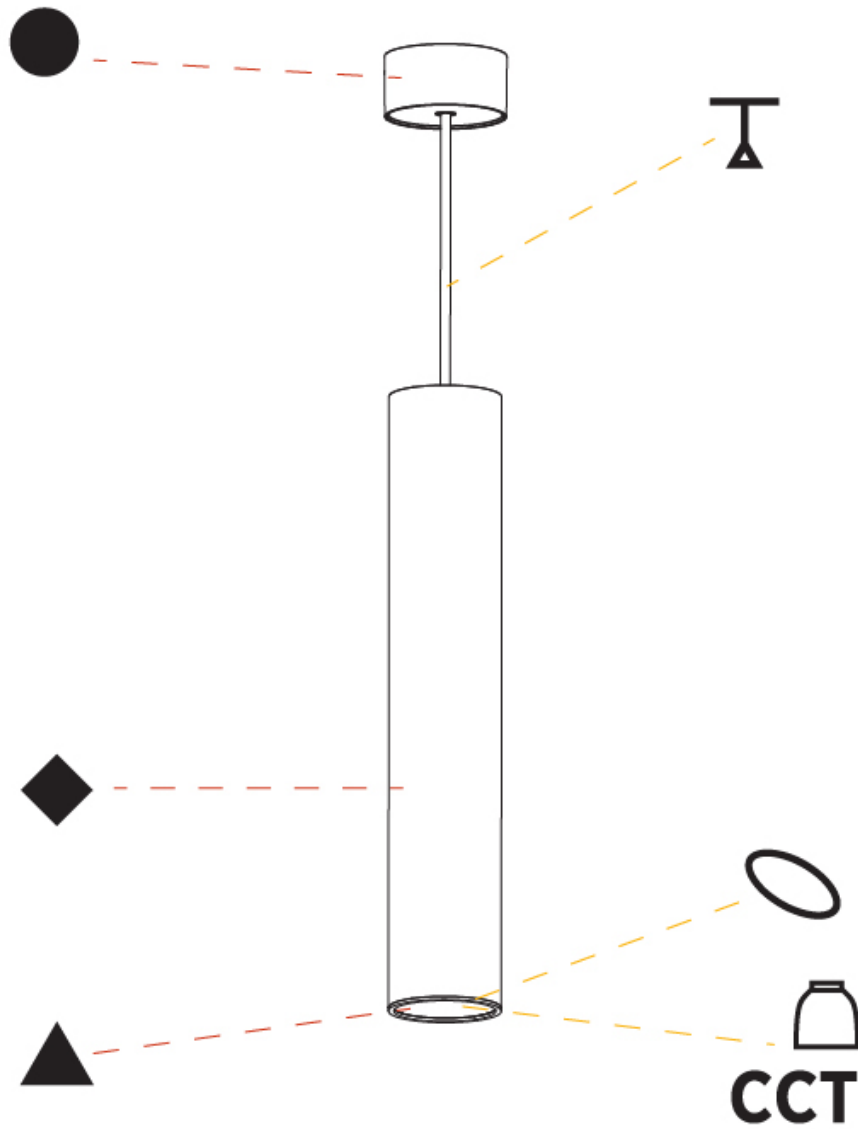

A

PROJECT _____
 TYPE _____
 SPECIFIER _____
 QUANTITY _____
 DATE _____

HANGOVER COLOR FINISH CHART

Fixture Finish

Sparkling Silver - 01 (SSR)



Black Velvet - 02 (BKV)



Crystal White - 03 (CWI)



Creamy - 04 (CRY)



Hampton Bay - 05 (HAB)



Urban Forest - 07 (UFT)



In the Army - 08 (ITA)



Rusty Angel - 09 (RUA)



Fade to Gray - 12 (FTG)



Mysterious Gray - 13 (MYG)



Lost Dream - 15 (LOD)



Purple Sky - 16 (PUS)



Fresh Oh - 17 (FRO)



Funky P. - 18 (FUP)



Kissing Aphrodite - 19 (KIA)



Poseidon's Paradise - 20 (POP)



Blue Sky - 21 (BLS)



Spring Green - 22 (SPG)

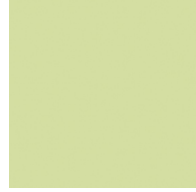

Mellow Yellow - 23 (MEY)



Golden Heart - 24 (GOH)



Champagne Cream - 26 (CHC)



Copper Mine - 27 (COM)



Ancient Bronze - 28 (ABZ)



Jazz Gold - 29 (JAG)



Olive Breeze - 30 (OBR)



Moonlight Silver - 31 (MOS)



Rosewood Red - 32 (ROR)



Digital: Not all screens are calibrated the same, and therefore, colors will appear differently between screens.

Physical: When texture is involved, there will be variations in color, character and tone within a product series and between product families.











Champagne Cream, Copper Mine, Ancient Bronze + Jazz Gold: These finishes have slight fading from specific powder coating production. Each luminaire will slightly vary.













LEGEND

| | | | | | |
|--|---|---|--|---|--|
|  | floor-mounted |  | pivotal |  | special LED (upon request) RGB, RGBW, tunable, gold+, meat+, art+, fashion+ |
|  | wall and ceiling: recessed and surface mounted |  | rotating |  | warm dim / natural dimming LED |
|  | ceiling-mounted and wall-mounted |  | illuminate tilted |  | rechargeable battery powered |
|  | wall-mounted |  | color of suspension cable |  | fixture with natural vivid LED (upon request) |
|  | omni-directional light distribution |  | length of suspension cable |  | color rendering index |
|  | direct light distribution |  | reflector degree selection |  | color temperature |
|  | direct/indirect light distribution |  | super spot |  | lumen (luminous flux) |
|  | indirect light distribution |  | lens |  | efficacy (lumens per watt) |
|  | asymmetric light distribution |  | lens pack |  | Unified Glare Rating (UGR) range from 5-40 |
|  | aura light distribution |  | shine ring |  | marine grade (AISI 316 stainless steel) |
|  | round wall or ceiling cut-out |  | integrated shine ring with diffuser |  | walk on |
|  | square wall or ceiling cut-out |  | free individual colors 01-29 |  | drive on |
|  | the supplied jig specifies the cutout dimensions |  | individual colors: 00 (free of charge), 01-25 (extra charge) |  | Dark Sky Compliance |
|  | minimum distance (meters) lamp - object |  | luminaire part to be colored (F1) |  | Americans with Disabilities Act (less than 4" off the wall located between 27"-84" from floor) |
|  | recessed depth |  | luminaire part to be colored (F2) |  | lamp protected against explosion |
|  | ceiling thickness in mm |  | luminaire part to be colored (F3) |  | blown glass using traditional methods by master glass blower |
|  | ceiling thickness selection |  | luminaire part to be colored (F4) |  | acoustic material |
|  | dimnable DP (phase), DV (0-10V), DD (dali), DS (step-dim) |  | luminaire part to be colored (F5) |  | protection class I, protection insulation |
|  | included or excluded LED driver/transformer/control gear |  | color of 3-circuit adaptor |  | protection class II, protection insulation |
|  | separately switchable |  | indirect diffuser |  | ETL Certified to UL and CSA Standards |
|  | sensor |  | direct diffuser |  | UL Certified to UL and CSA Standards |
|  | remote control |  | ball-proof (upon request) |  | CSA Certified to UL and CSA Standards |
|  | available upon request |  | accessory |  | Certified for North American Standards |

IP RATING

| | |
|---|--|
|  | protected against ingress of solid bodies greater than 12.5mm (finger) |
|  | protected against ingress of solid bodies greater than 2.5mm protected against sprays of water up to 60 degrees from the vertical (rain) |
|  | protected against ingress of solid bodies greater than 1mm (wire) no protection against the ingress of moisture |
|  | protected against ingress of solid bodies greater than 1mm (wire) protected against sprays of water up to 60 degrees from the vertical (rain) |
|  | protected against ingress of solid bodies greater than 1mm (wire) protected against water splashed from all directions |
|  | protected against limited ingress of dust (wet rooms/covered outdoor areas) protected against water splashed from all directions |
|  | protected against ingress of dust protected against jets of water |
|  | protected against ingress of dust protected against powerful jets of water or heavy seas |
|  | protected against ingress of dust protected against immersion of water between 15cm - 1m for 30 minutes |
|  | protected against ingress of dust protected against immersion of water under pressure for long periods |

IK RATING

| | |
|---|---|
|  | protected against 0.14 joules impact (equivalent to 0.25kg mass dropped from 56mm above the surface) |
|  | protected against 0.2 joules impact (equivalent to 0.25kg mass dropped from 80mm above the surface) |
|  | protected against 0.35 joules impact (equivalent to 0.25kg mass dropped from 140mm above the surface) |
|  | protected against 0.5 joules impact (equivalent to 0.25kg mass dropped from 200mm above the surface) |
|  | protected against 0.7 joules impact (equivalent to 0.25kg mass dropped from 280mm above the surface) |
|  | protected against 1 joules impact (equivalent to 0.25kg mass dropped from 400mm above the surface) |
|  | protected against 2 joules impact (equivalent to 0.5kg mass dropped from 400mm above the surface) |
|  | protected against 5 joules impact (equivalent to 1.7kg mass dropped from 300mm above the surface) |
|  | protected against 10 joules impact (equivalent to 5.0kg mass dropped from 200mm above the surface) |
|  | protected against 20 joules impact (equivalent to 5.0kg mass dropped from 400mm above the surface) |